

Bilag 2  
**Vesterport banegrav**  
Uddrag af projektmateriale





Området i dag

**WERK**



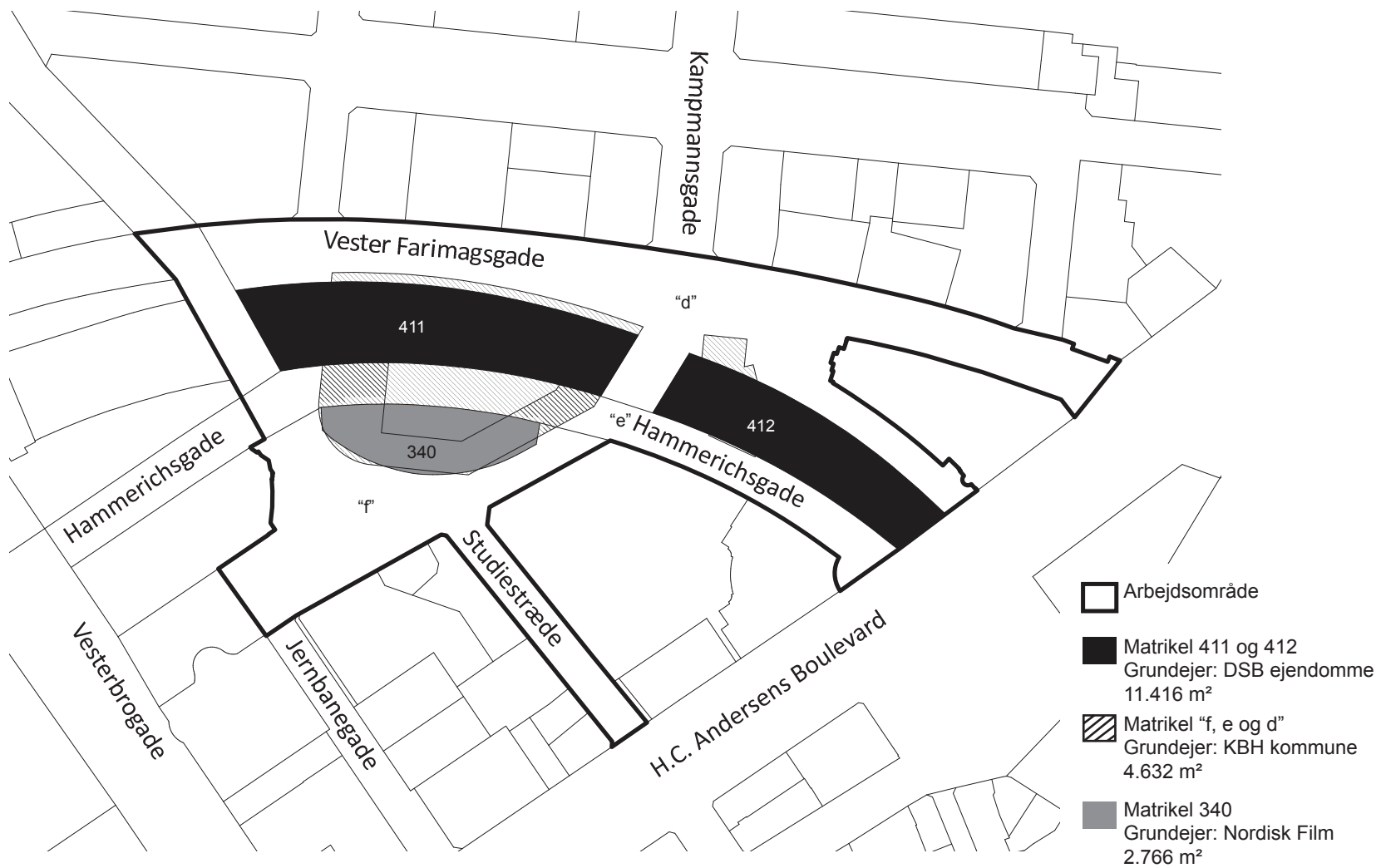

# MATRIKLER

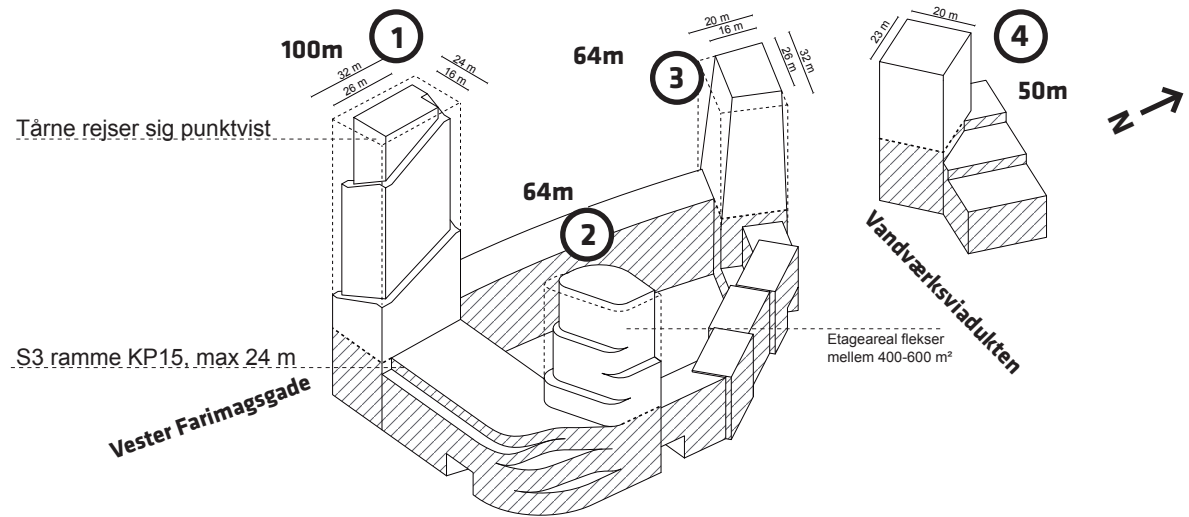

# VOLUMEN



-  S3 ramme KP15, max 24 m  
Samlet etagemeter: 49.800 m<sup>2</sup>
-  Punktvise tårnbebyggelser  
Samlet etagemeter: 25.300m<sup>2</sup> - 31.300 m<sup>2</sup>
-  Flekszone for tårnernes bredde i forhold til funktion og teknik

22.

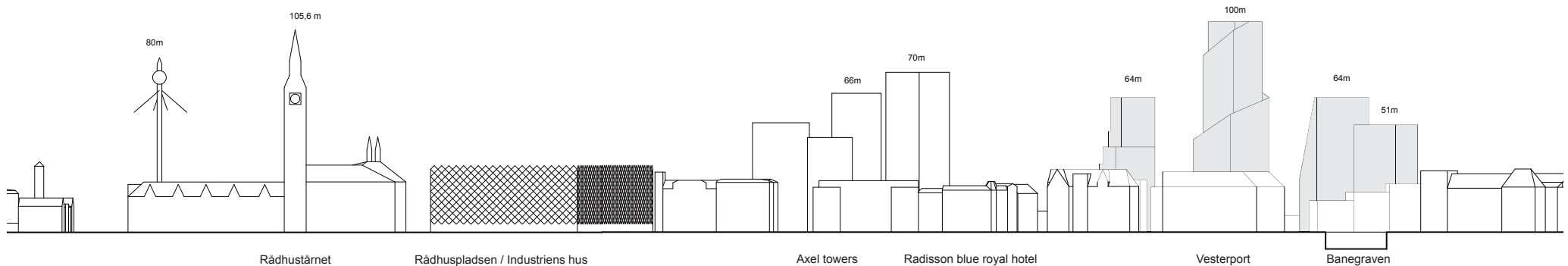

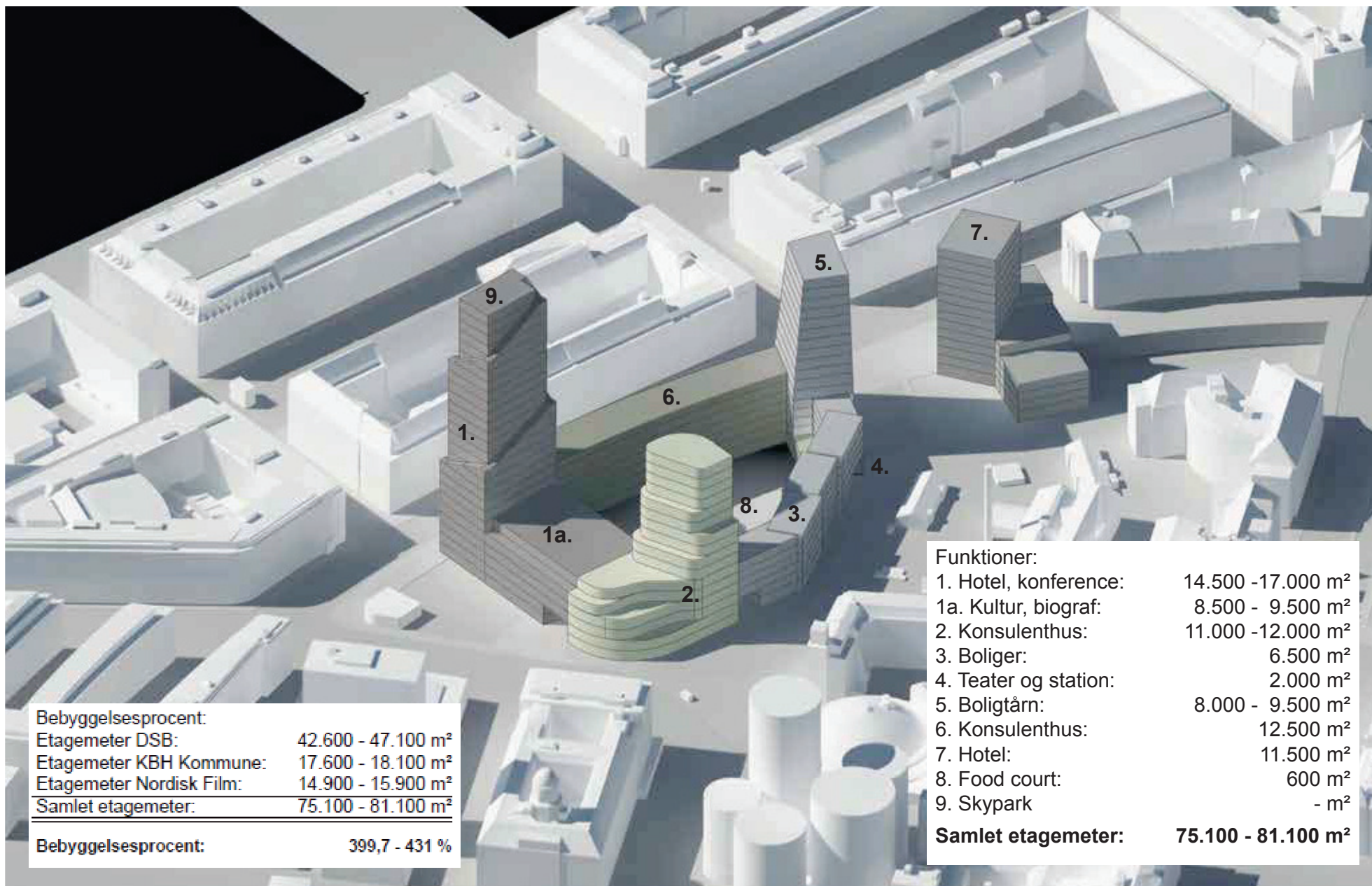

Bebyggelsesprocent:	
Etagemeter DSB:	42.600 - 47.100 m <sup>2</sup>
Etagemeter KBH Kommune:	17.600 - 18.100 m <sup>2</sup>
Etagemeter Nordisk Film:	14.900 - 15.900 m <sup>2</sup>
<b>Samlet etagemeter:</b>	<b>75.100 - 81.100 m<sup>2</sup></b>

**Bebyggelsesprocent:** 399,7 - 431 %

<b>Funktioner:</b>	
1. Hotel, konference:	14.500 - 17.000 m <sup>2</sup>
1a. Kultur, biograf:	8.500 - 9.500 m <sup>2</sup>
2. Konsulenthus:	11.000 - 12.000 m <sup>2</sup>
3. Boliger:	6.500 m <sup>2</sup>
4. Teater og station:	2.000 m <sup>2</sup>
5. Boligtårn:	8.000 - 9.500 m <sup>2</sup>
6. Konsulenthus:	12.500 m <sup>2</sup>
7. Hotel:	11.500 m <sup>2</sup>
8. Food court:	600 m <sup>2</sup>
9. Skypark	- m <sup>2</sup>
<b>Samlet etagemeter:</b>	<b>75.100 - 81.100 m<sup>2</sup></b>





WERK



WERK

# PARKERING

