

Bilag 2
Vesterport banegrav
Uddrag af projektmateriale



Området i dag

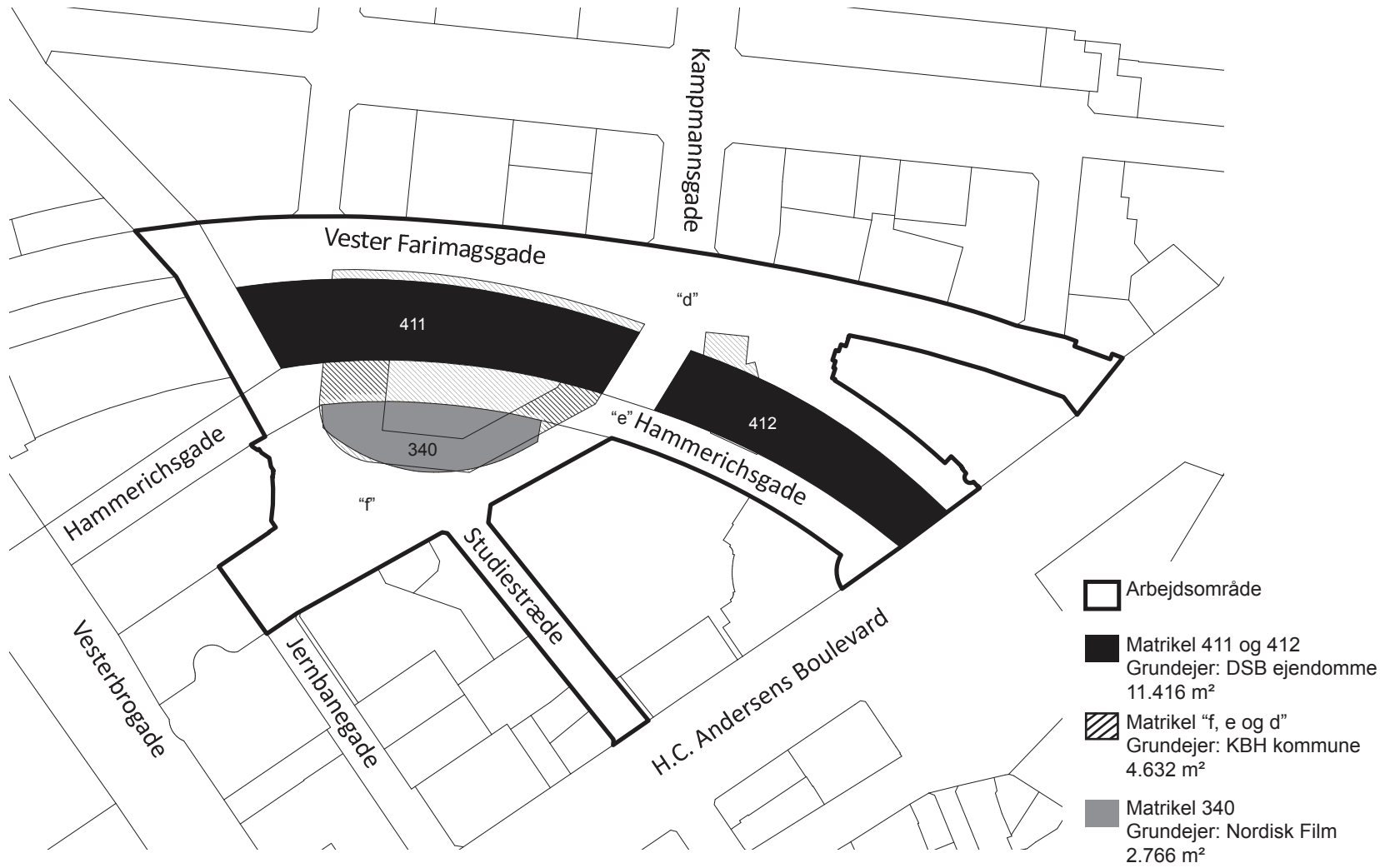

WERK

MATRIKLER

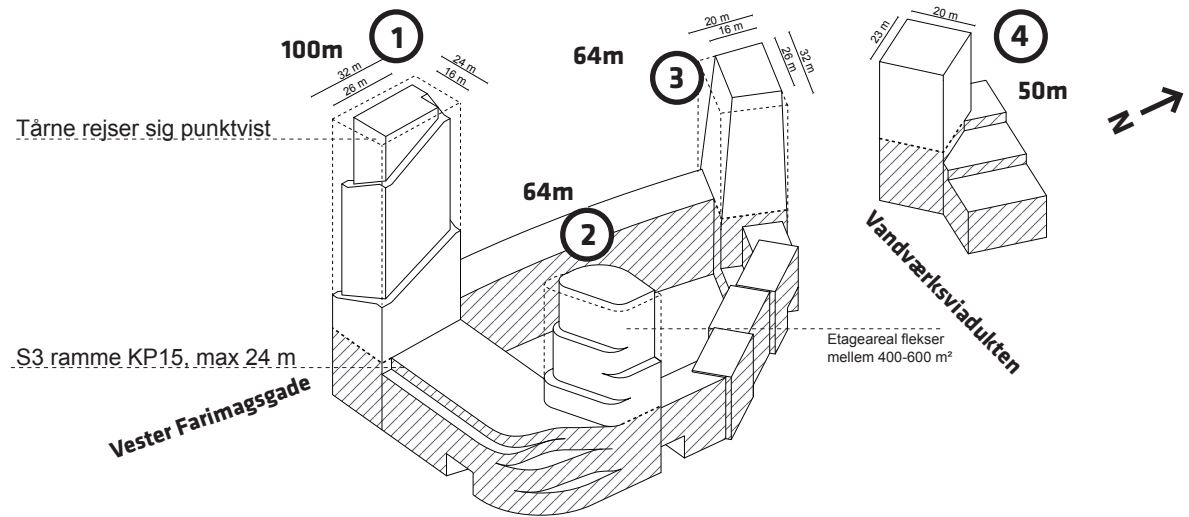

VOLUMEN



-  S3 ramme KP15, max 24 m
Samlet etagemeter: 49.800 m²
-  Punktvise tårnbebyggelser
Samlet etagemeter: 25.300m² - 31.300 m²
-  Flekszone for tårnenes bredde i forhold til funktion og teknik

22.

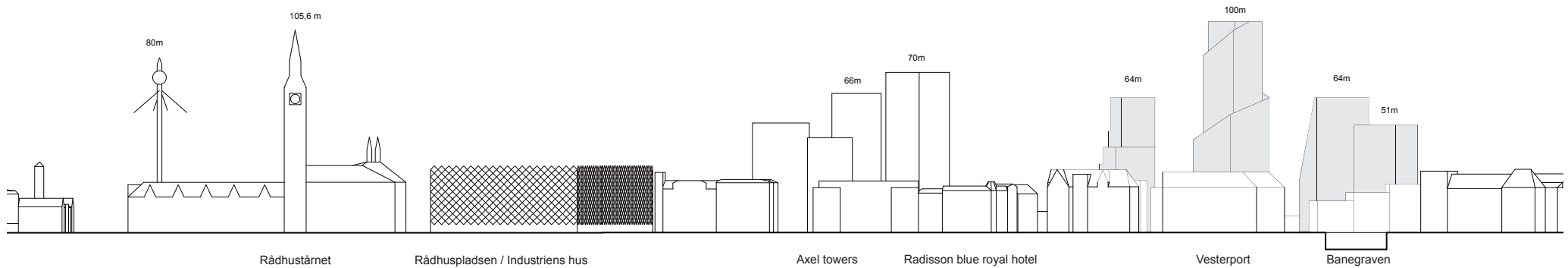

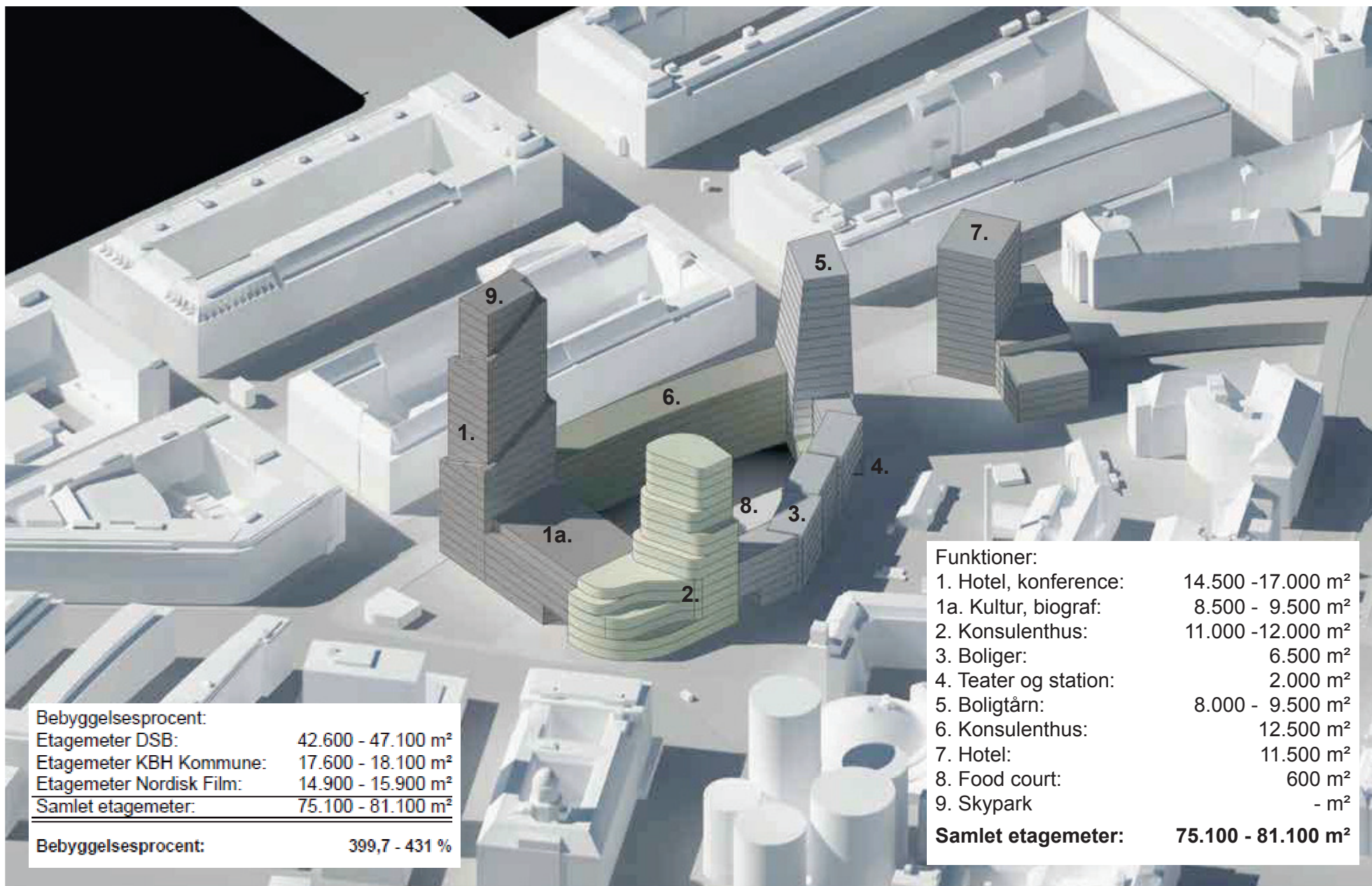

Bebyggelsesprocent:	
Etagemeter DSB:	42.600 - 47.100 m ²
Etagemeter KBH Kommune:	17.600 - 18.100 m ²
Etagemeter Nordisk Film:	14.900 - 15.900 m ²
Samlet etagemeter:	75.100 - 81.100 m²

Bebyggelsesprocent: 399,7 - 431 %

Funktioner:	
1. Hotel, konference:	14.500 - 17.000 m ²
1a. Kultur, biograf:	8.500 - 9.500 m ²
2. Konsulenthus:	11.000 - 12.000 m ²
3. Boliger:	6.500 m ²
4. Teater og station:	2.000 m ²
5. Boligtårn:	8.000 - 9.500 m ²
6. Konsulenthus:	12.500 m ²
7. Hotel:	11.500 m ²
8. Food court:	600 m ²
9. Skypark	- m ²
Samlet etagemeter:	75.100 - 81.100 m²



WERK



WERK

PARKERING

