

TØNDERGADE

Eksisterende bebyggelse

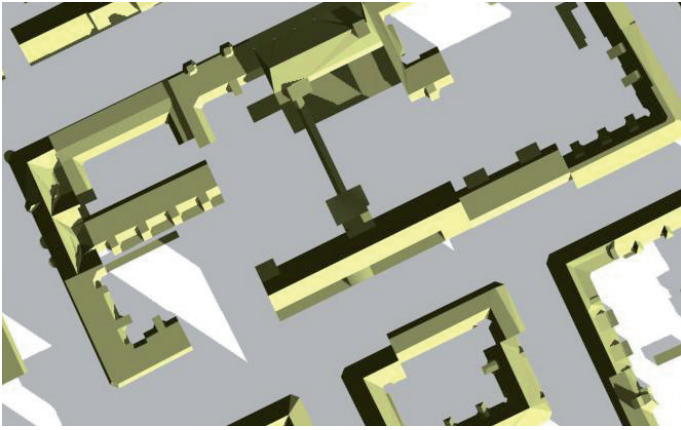

21. marts kl. 09

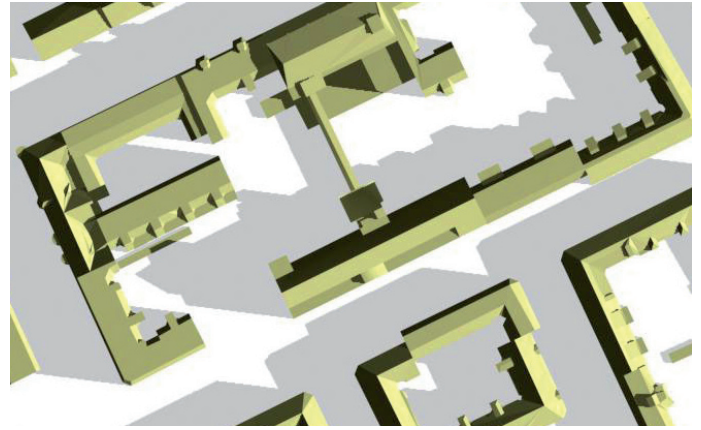

21. juni kl. 9, sommertid

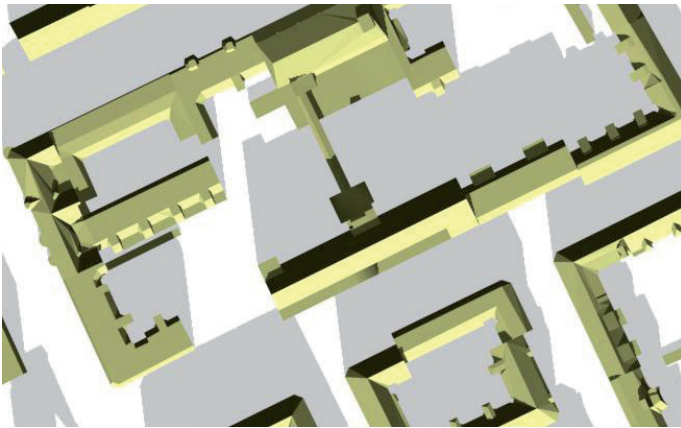

21. marts kl. 12

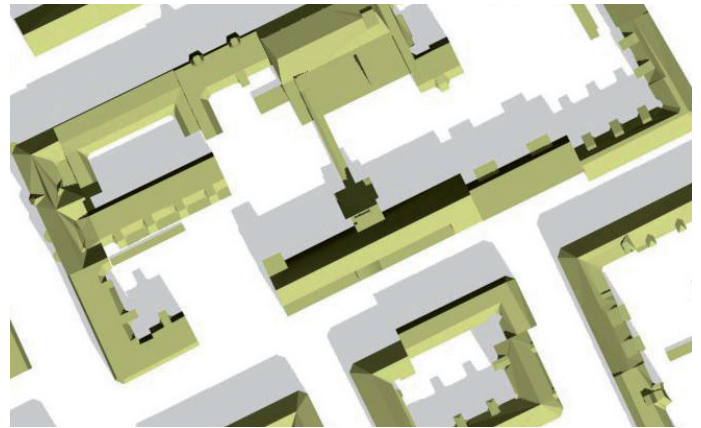

21. juni kl. 12, sommertid

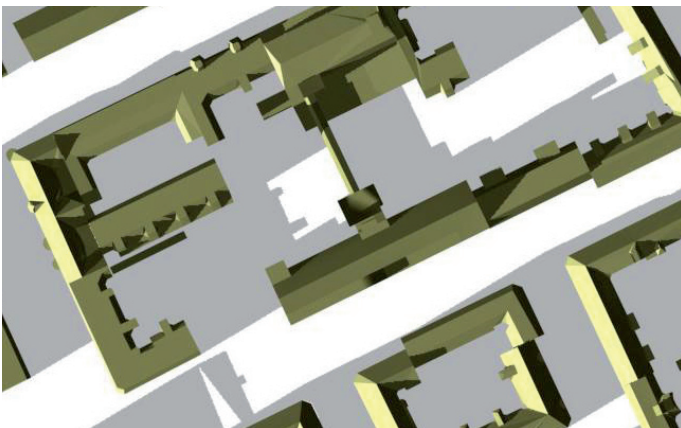

21. marts kl. 16

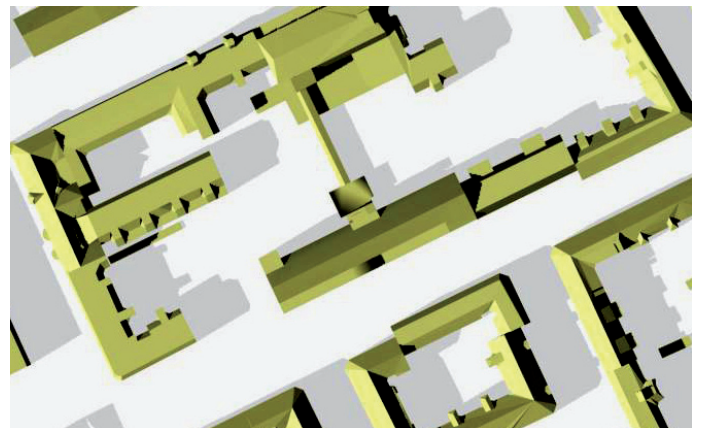

21. juni kl. 16, sommertid

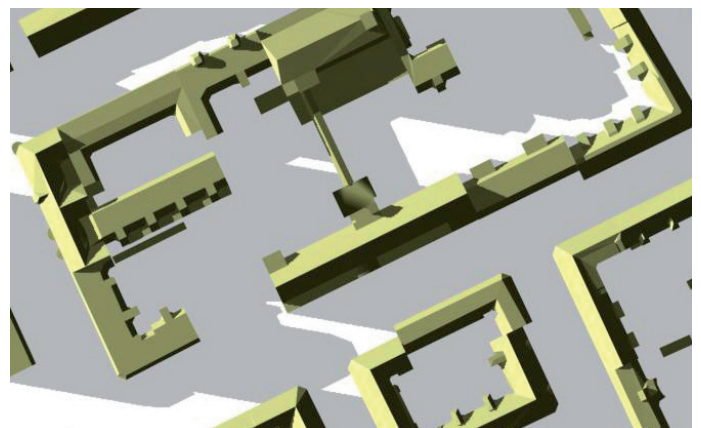

21. juni kl. 19, sommertid

TØNDERGADE

Planlagt bebyggelse

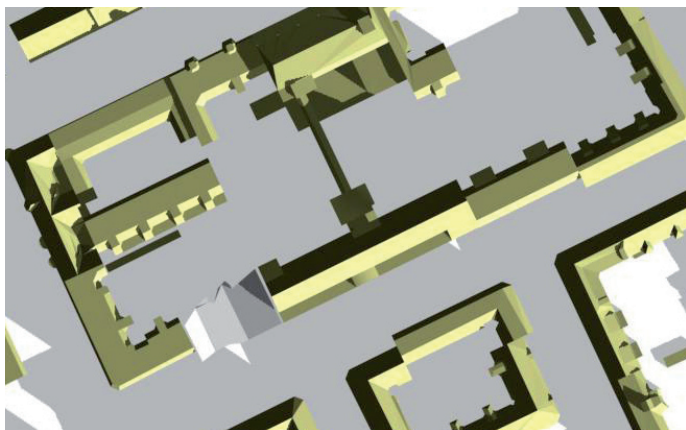

21. marts kl. 09

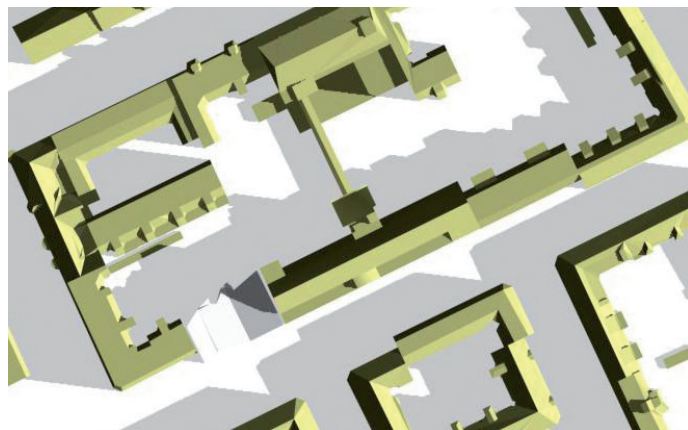

21. juni kl. 9, sommertid

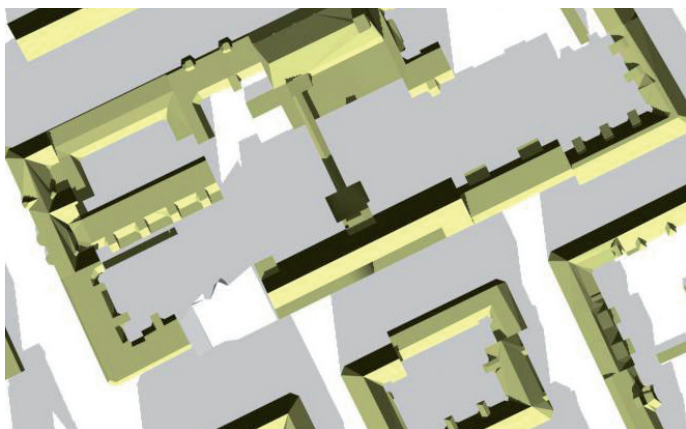

21. marts kl. 12

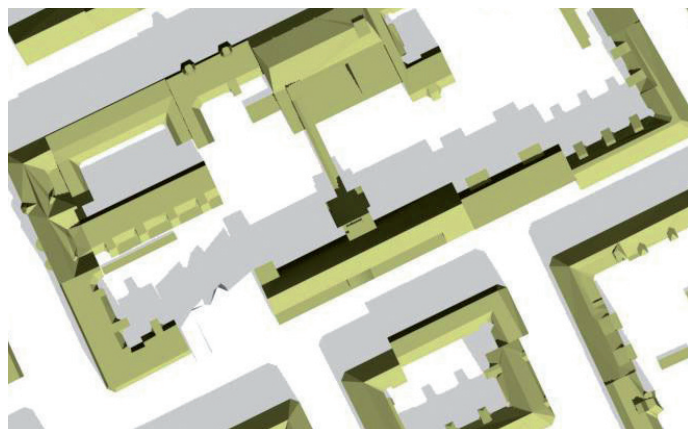

21. juni kl. 12, sommertid

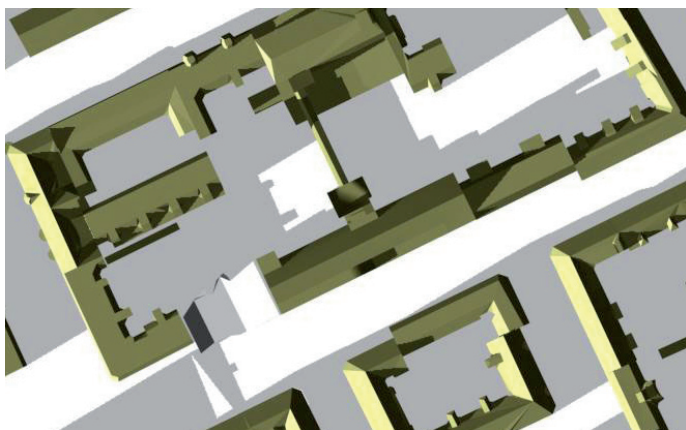

21. marts kl. 16

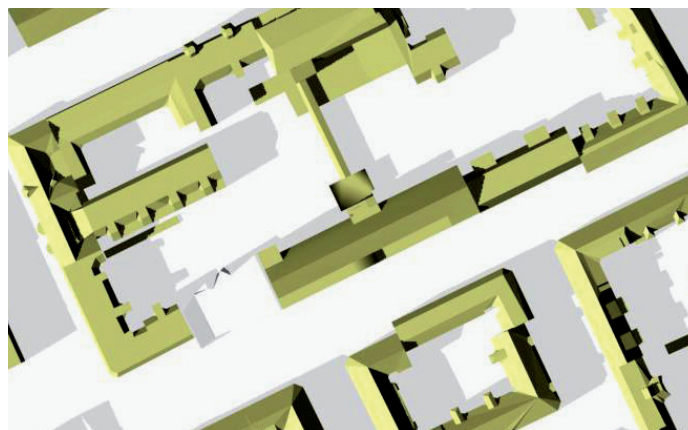

21. juni kl. 16, sommertid

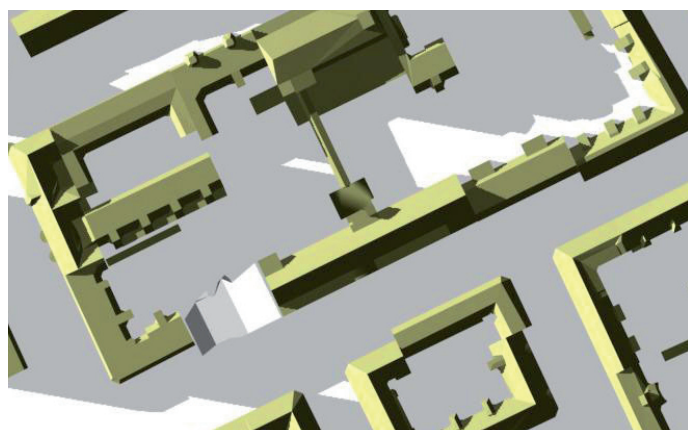

21. juni kl. 19, sommertid

